



0800 000 168

14 Harrow Street, Dunedin

tmcteam.co.nz

PL-300

Deployable portable lighting in one bespoke robust package.

Petal Light Tower



SCAN ME



HIGHER, BRIGHTER, MORE STABLE

10-second rapid expansion, easy adjustment
of four lighting angles.

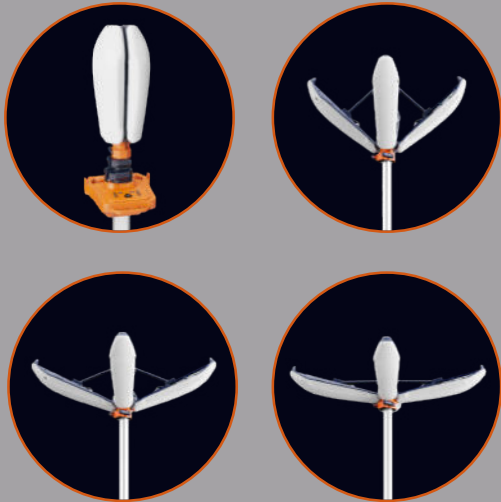

Original petal-shaped adjustable
head offers 360-degree wide-angle
illumination, from all directions to
directly below the light.

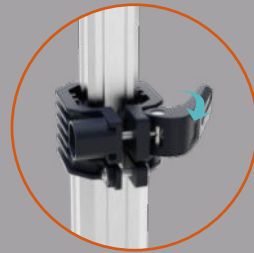

Ground pegs are available
to secure the light tower,
providing wind and
vibration resistance.
(Optional)

One-click release or
lock of the legs.

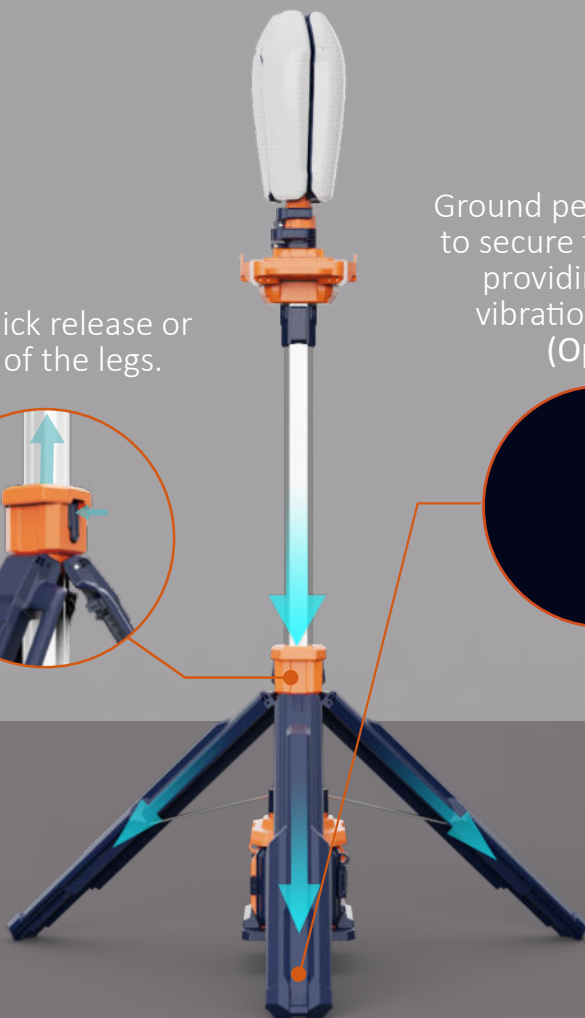
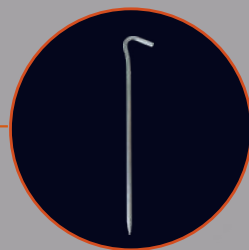
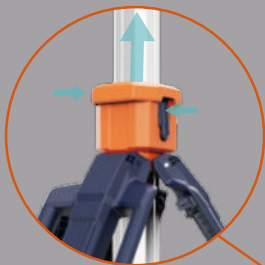

HUMANIZED DESIGN HIDDEN IN THE DETAILS

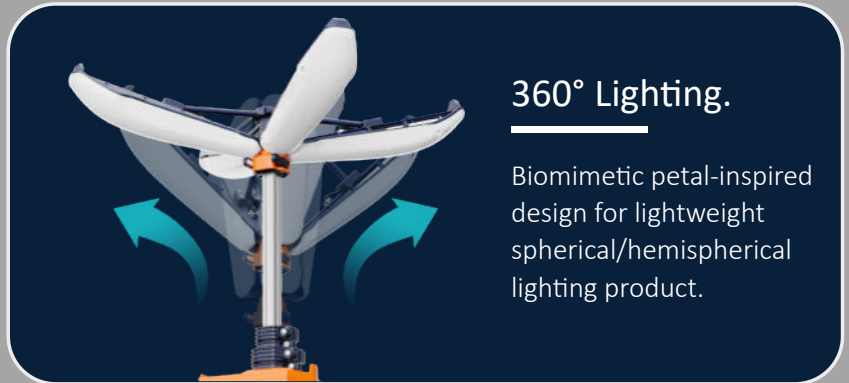

360° Lighting.

Biomimetic petal-inspired design for lightweight spherical/hemispherical lighting product.



USB Output

Dual rainproof USB outputs for charging two devices at once, rain or shine.

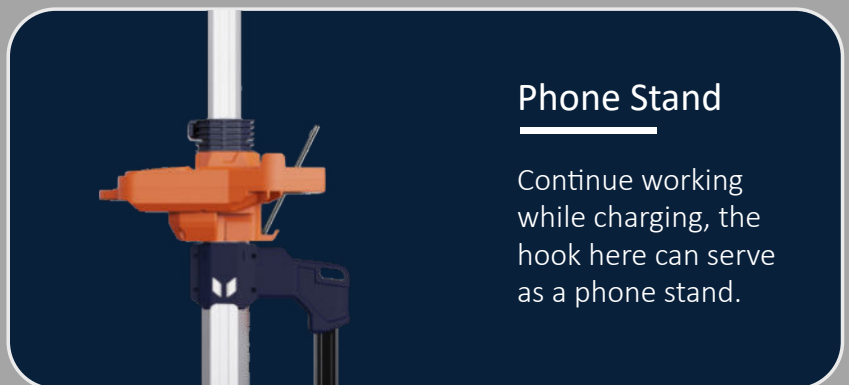

Phone Stand

Continue working while charging, the hook here can serve as a phone stand.



Stepless Dimming

Plug the driver into the rainproof port to unlock maximum brightness and stepless dimming.

LOWER CENTER OF GRAVITY, GREATER STABILITY

Ultra-low center of gravity combined with extended legs effortlessly handles strong winds and slopes within 30 degrees.



Ultra-long working hours

Standard Mode Up To **13+** Hours
(D24-100)

Battery compartment fits two replaceable battery packs.



2 types of battery packs with different capacities have same contact slot.



D24-54



D24-100

Typical working hours 35+ hours on PL-300 Eco mode.

Doubled typical working hours to 70+ hours.

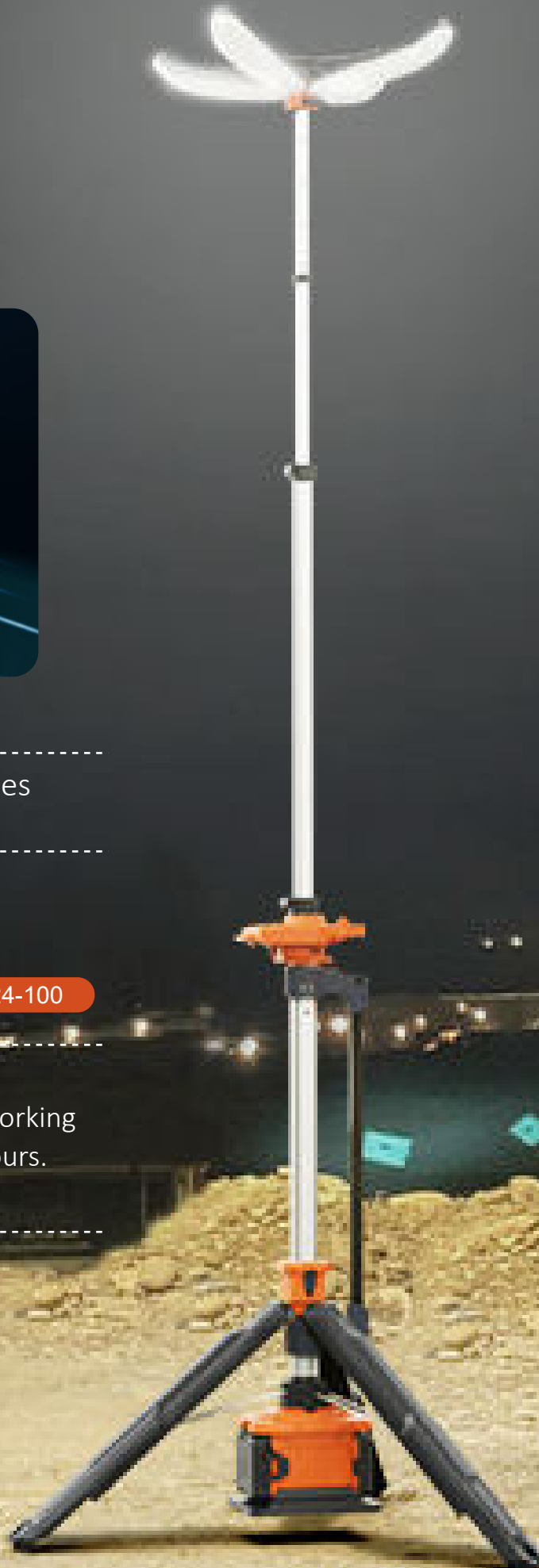

Uniform and non-glaring 360-degree illumination, leaving no dark spots.

- Lighting Area 2200 m²

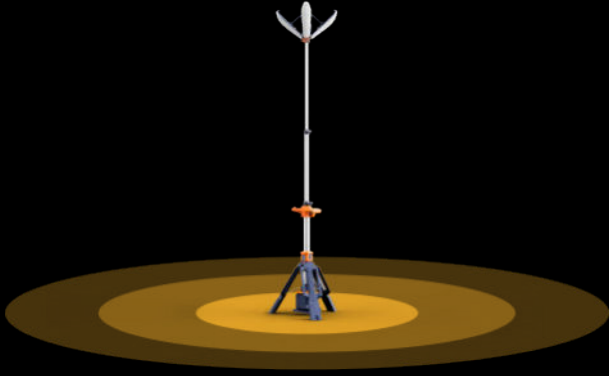

AC Powered

Up To **14,000** LM

Battery-powered

Up To **8,000** LM

Stepless Dimmable (AC Powered)

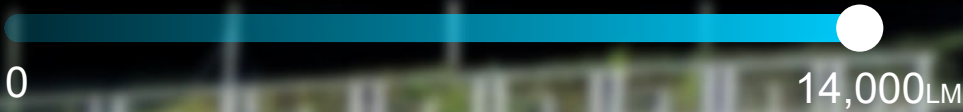

4 levels of Brightness (Battery Powered)

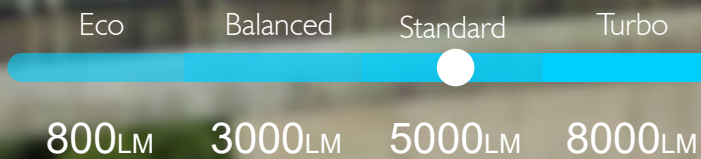



Construction



Maintenance



Rescue



Emergency



Railway



Mining



Camping

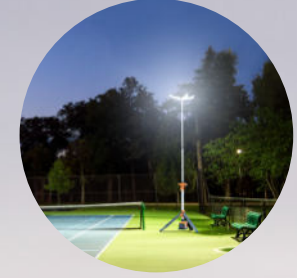

Sport

Designed for single-person operation

Easy to grip and move,
weight 8.7 kg excluding battery pack.



1.58m



3.4m



Specifications

PL-300

Height	1.58m~3.4m
Weight	8.67Kg (Fitting only)
Power Supply	D24 series battery pack / AC 100-277V
Lumens	0 - 14,000Lm
Run Times	>13 hours (Standard mode, D24-100)
IP Grade	IP66
Output(USB)	5V 2A (2 Dock)



Size (mm)

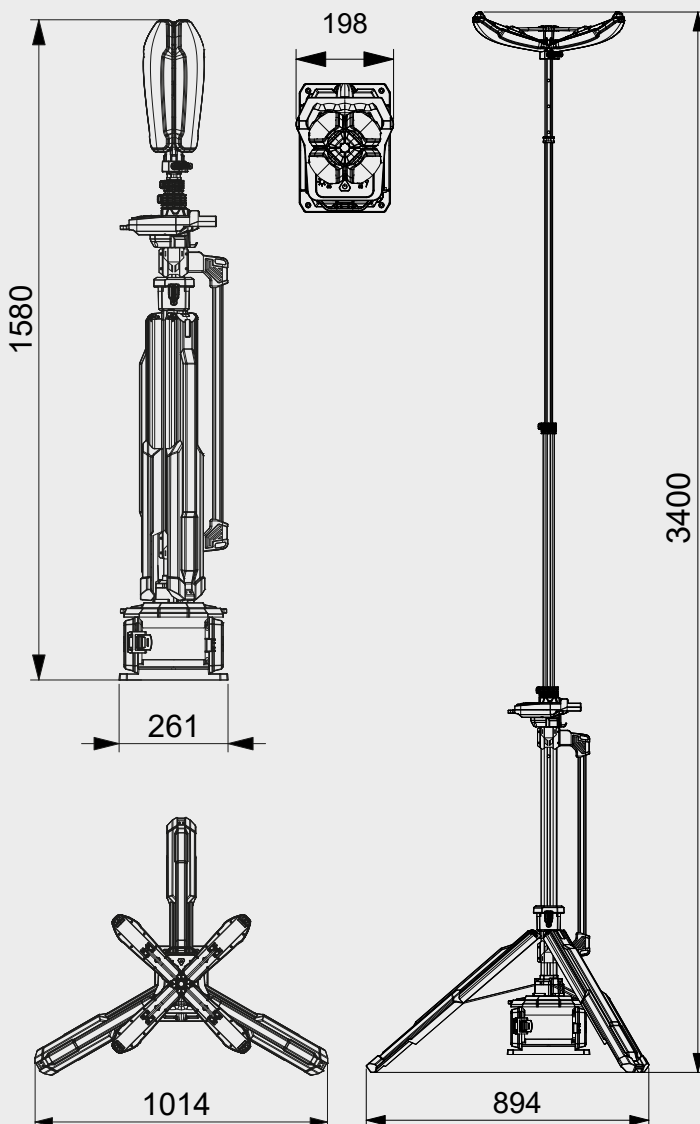

Package

Model	PL-300
Size of Carton	1660x290x380mm
Gross Weight of Carton	11.5KG
PCS/Carton	1



TRAFFIC MANAGEMENT & CONTROL LTD

Tel: 0800 000 168

Web: tmcteam.co.nz

E-mail: sales@tmcteam.co.nz

Address: 14 Harrow Street, Dunedin

